

■ DRAGON2



■ DRAGON2

■ DRAGON2



pop up - Faltwand

- komplett magnetisch!

■ dragon2 curved / gebogen



1x3



2x3

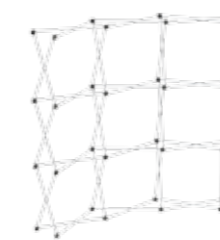

3x3

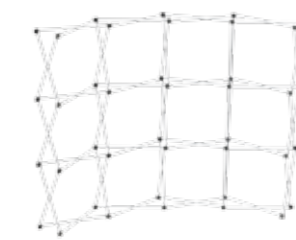

4x3

■ dragon2 straight / gerade



1x3

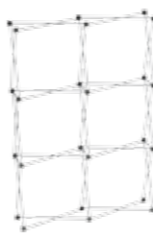

2x3

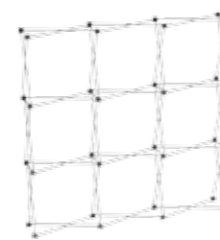

3x3

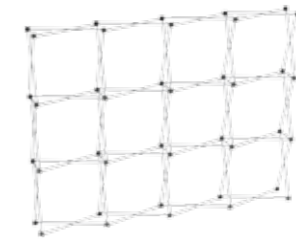

4x3

pop up - folding wall

- fully magnetic!

- | | |
|--|--|
| ■ self-aligning magnetic panels | ■ selbstarretierende Magnetpaneele |
| ■ choose straight, curved or a combination of both to create a unique look | ■ Systeme gerade, gebogen oder eine Kombination aus beiden Varianten |
| ■ easy attachment of various accessories (monitor holder - TFT, lighting etc.) | ■ einfaches Anbringen von diverserem Zubehör (Bildschirmhalterung, Beleuchtung usw.) |
| ■ optional: full wrap available - covers front, sides and rear | ■ rundum Bestückung möglich |
| ■ various packing options available (podium case, softcase etc.) | ■ verschiedene Verpackungsoptionen (Thekenkoffer, Softcase usw.) |
| ■ custom sizes on request | ■ Sonderformen auf Anfrage erhältlich |
| ■ spare parts available | ■ Ersatzteile erhältlich |

Accessories / Zubehör

halogen or LED lamp / Halogenfluter oder LED-Lampe



monitor holder (TFT) / Bildschirmhalterung



product shelf / Produktablage



brochure shelf / Prospektablage



tablet holder / Tablethalterung



display cabinet / Einbauvitrine



system details / Systemdetails

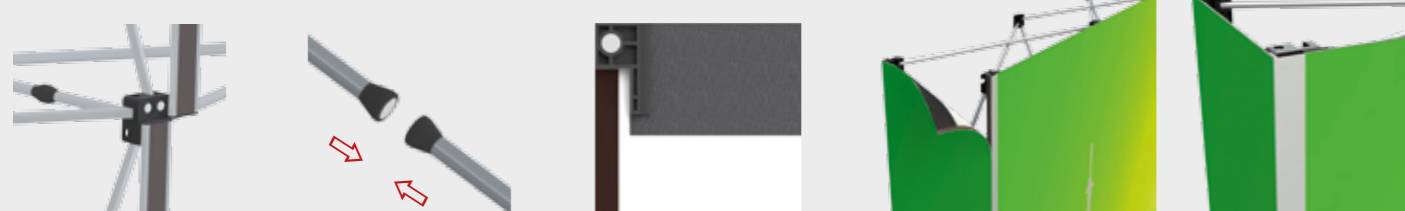

assembly / Aufbau



pop up_tower

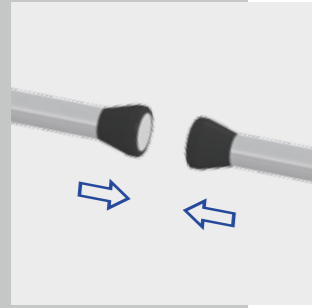

folding tower / faltbare Werbesäule

– fully magnetic! / komplett magnetisch!

- | | |
|---|--|
| ■ self-aligning magnetic panels | ■ selbstarretierende Magnetpaneele |
| ■ magnetic locking device | ■ magnetische Systemverriegelung |
| ■ simple tool-less assembly | ■ schneller, werkzeugloser Aufbau |
| ■ full wrap - covers front and rear | ■ System rundum bestückt |
| ■ system dimensions - mounted
WxDxH 65x65x225 cm | ■ Systemmaße aufgebaut
BxTxH 65x65x225 cm |
| ■ weight approx. 13 kg | ■ Gewicht ca. 13 kg |
| ■ optional: transport case with wheels | ■ rollbarer Transportkoffer als Zubehör erhältlich |
| ■ spare parts available | ■ Ersatzteile erhältlich |

assembly / Aufbau

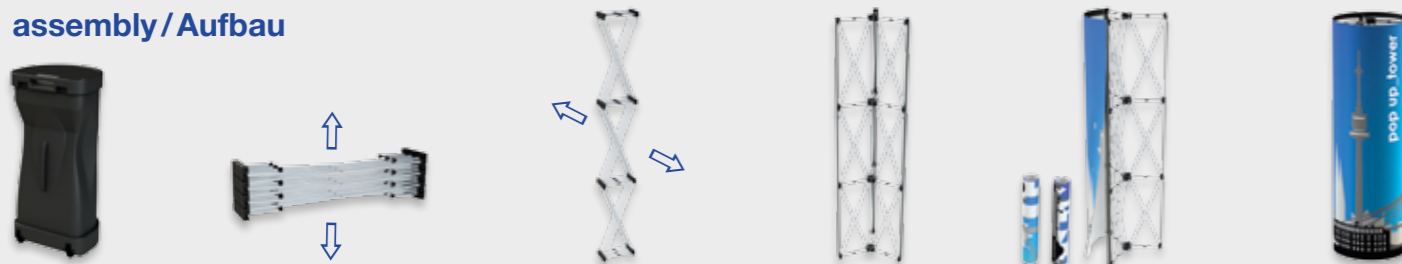

pop up_counter 2



folding counter / Falttheke

– fully magnetic! / komplett magnetisch!

- | | |
|---|--|
| ■ self-aligning magnetic panels | ■ selbstarretierende Magnetpaneele |
| ■ magnetic locking device | ■ magnetische Systemverriegelung |
| ■ simple tool-less assembly | ■ schneller, werkzeugloser Aufbau |
| ■ system dimensions - mounted
WxDxH 128x45x97,5 cm | ■ Systemmaße aufgebaut
BxTxH 128x45x97,5 cm |
| ■ weight approx. 23 kg | ■ Gewicht ca. 23 kg |
| ■ counter top in black or wooden design | ■ Deckplatte in schwarz oder im Holzdesign |
| ■ optional: full wrap available -
covers front, sides and rear | ■ rundum Bestückung möglich |
| ■ incl. transport case with wheels | ■ inkl. rollbarem Transportkoffer |
| ■ spare parts available | ■ Ersatzteile erhältlich |

assembly / Aufbau

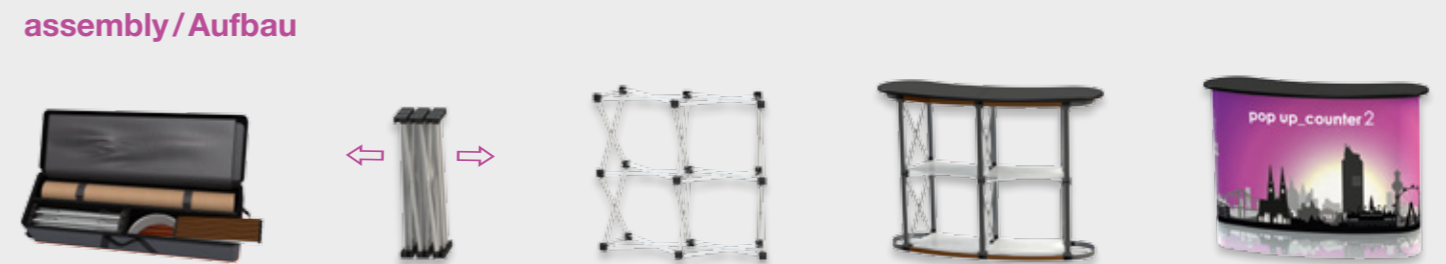

DRAGON2

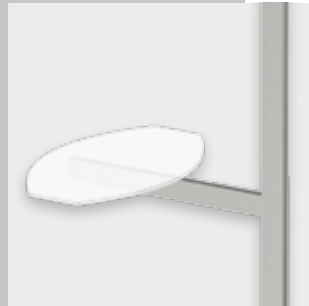

pop up Zubehör - individuelle Gestaltung möglich!



pop up accessories - individual design possible!

- individual design possible!

- | | |
|---|--|
| ■ modular holder for small screens | ■ modulare Halterung für kleine Bildschirme |
| ■ modular holder for large screens with floor support | ■ modulare Halterung für große Bildschirme mit Bodenabstützung |
| ■ product shelf | ■ Produktablage |
| ■ single brochure shelf A4 | ■ Einzelprospektablage A4 |
| ■ display cabinet incl. 2 shelves & transport bag | ■ Vitrine inkl. 2 Ablagen & Transporttasche |
| ■ tablet holder | ■ Tablethalterung |
| ■ header for pop up_counter | ■ Header für pop up_counter |
| ■ magnetic 3D applications - customized | ■ magnetische 3D Applikationen - individuell gestaltbar |

bags & cases / Taschen & Koffer

bag for 2 lamps /
Tasche für 2 Lampen



bag for monitor holder
(TFT) or product shelf /
Tasche für Bildschirm-
halterung oder
Produktablage



transport softcase /
Transportkoffer
(softcase)



transport case /
Transportkoffer



podium case /
Thekenkoffer



system details / Systemdetails



magnetic 3D applications / magnetische 3D Applikationen

